

SPECIFICATION



90t



47m



65.5m

SRC900T

SANY ROUGH TERRAIN CRANE

QUALITY CHANGES THE WORLD

crane.sanyglobal.com



Strong Lifting Capacity

超强性能

All New Operator's Cab

Ergonomic concept of safety and comfort

全新操纵室

操作安全、舒适、人机工程全面升级

Quality Components

DF Cummins engine/Dana transmission/Meritor axles

高质量关键件

东风康明斯发动机/德纳变速箱/美驰车桥

Convenient Transport

One-trailer transport at low operational cost

超便捷运输

一车整运，运营成本低



Convenient Transport

行驶运输便捷性

Four steering modes

四种转向模型

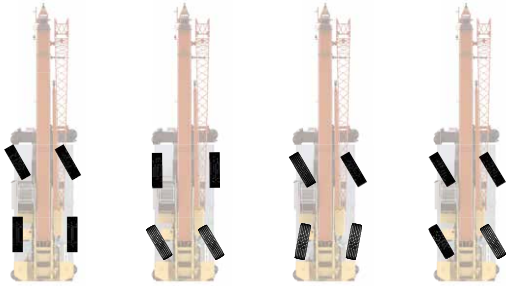

- 2 wheel front 前轮转向模式
- 2 wheel rear 后轮转向模式
- 4 wheel 四轮转向模式
- Crab 蟹行模式



Steering control panel
转向控制面板

One-Trailer Transport

一车整运

The basic machine is transported at 54t with counterweight, jib and hooks, 3.34m wide and 3.83m high, satisfying road regulations.

主机运输尺寸为宽 3.34m, 高 3.83m, 重量为 54t (带配重、副臂和吊钩), 满足道路运输要求。

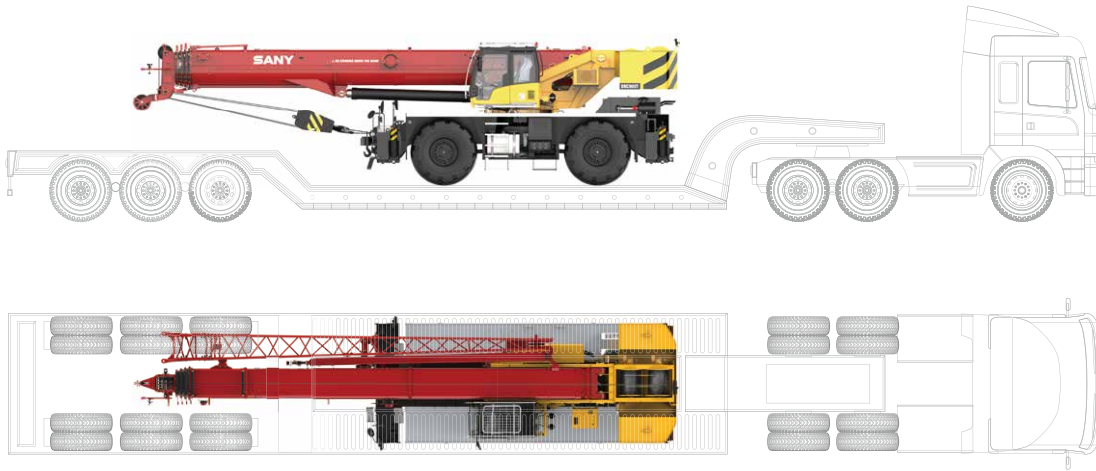

Axle Load Distribution

轴荷分布

Items 项目		Weight (kg) 重量	Load on front axle (kg) 前轴轴荷	Load on rear axle (kg) 后轴轴荷
Basic machine 主机		54000	27200	26800
Counterweight 配重		9500	-3100	12600
Fixed jib 副臂		1100	1800	-700
Aux. boom nose 臂尖滑轮		50	150	-100
Main hook 主钩	70t	690	1960	-1270
Main hook (optional) 主钩 (选配)	90t	830	2350	-1520
Auxiliary hook 副钩	8t	160	240	-80

Note: boom angle remains 0°
起重臂角度 0°

Carrier Frame

车架底盘



Inverted trapezoidal variable cross section frame is 5% less in weight and 10% stronger in rigidity.

倒梯形变截面车架，实现车架减重 5% 的同时，刚性提升 10%。

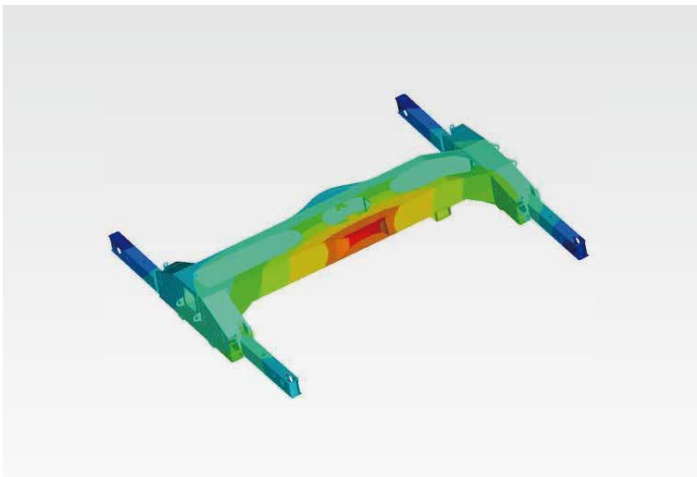

↓ 5%
Weight 重量

↑ 10%
Rigidity 刚性

Overall Dimensions

整机尺寸

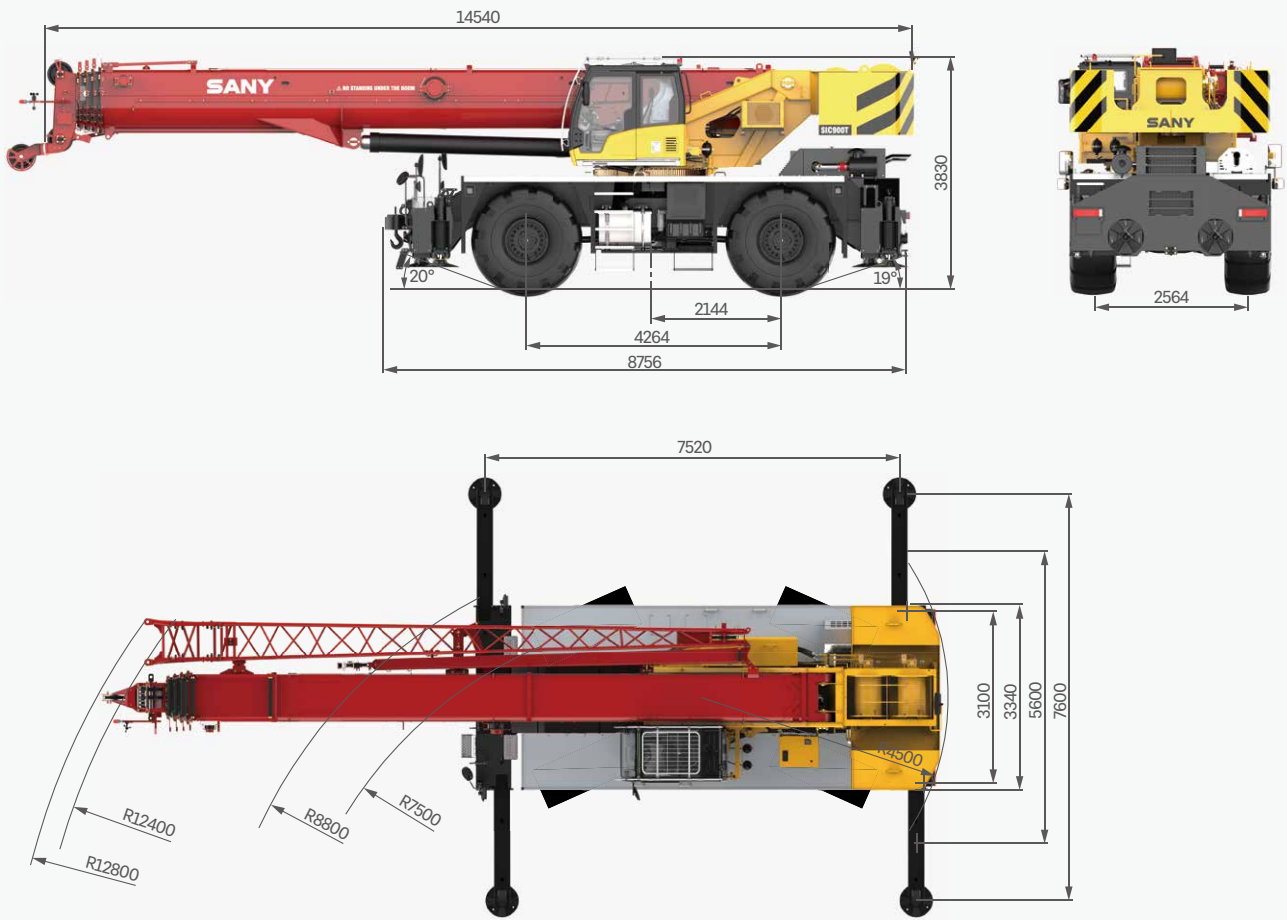

Technical Specification

整机参数

CATEGORY 类型	ITEM 项目	UNIT 单位	VALUE 参数	
CAPACITY 额定起重量	Max. lifting capacity 最大起重量	t	90	
WEIGHT 重量参数	Gross weight 整机总质量	kg	54000	
POWER 发动机参数	Engine model 发动机型号	-	QSB6.7 (Stage III)	
	Max. engine power 发动机最大功率	kW/rpm	194/2400	
	Max. engine torque 发动机最大输出扭矩	N·m/rpm	990/1500	
DIMENSIONS 尺寸参数	Overall length 整机全长	mm	14540	
	Overall width 整机全宽	mm	3340	
	Overall height 整机全高	mm	3830	
TRAVEL 行驶参数	Max. travel speed 最高行驶速度	km/h	35	
	Steering radius 转弯半径	Min.steering radius 最小转弯半径	m	7.5
		Min.steering radius of boom tip 臂头最小转弯半径	m	12.8
	Wheel formula 车轮模式	-	4 × 2; 4 × 4	
	Min.ground clearance 最小离地间隙	mm	530	
	Approach angle 接近角	°	20	
	Departure angle 离去角	°	19	
	Max.gradeability 最大爬坡度	-	75%	
	Fuel consumption per 100km 每 100 公里油耗	L	100	
	MAIN PERFORMANCE 主要性能参数	Working temperature range 使用温度区间	°C	-20~+46
Min.rated lifting radius 最小额定幅度		m	2.5	
Tail slewing radius 转台尾部回转半径		m	4.5	
Boom sections (Qty.) 臂节数		-	5	
Boom shape 臂形状		-	U shape U 型	
Max.lifting moment 最大起重力矩		Basic boom 基本臂	kN·m	2940
		Full-extension boom 全伸主臂	kN·m	1442
		Full-extension boom + jib 全伸主臂 + 副臂	kN·m	668
Boom length 臂长		Basic boom 基本臂	m	12.2
		Full-extension boom 全伸主臂	m	47
		Full-extension boom + jib 全伸主臂 + 副臂	m	65
Max.lifting height 最大起重高度		Basic boom 基本臂	m	13
		Full-extension boom 全伸主臂	m	47.5
		Full-extension boom + jib 全伸主臂 + 副臂	m	65.5
Outrigger span (Longitudinal × Transverse) 支腿跨距 (纵 × 横)		m	7.52 × 7.6	
Jib offset 副臂安装角度	°	0, 20, 40		
AIRCONDITIONER 空调	In operator's cab 上车空调	-	Heating & cooling 制冷、制热	

Technical Specification

整机参数



Axle Load 轴荷

Axle 轴	1	2	Gross weight 总重量
Axle load 轴荷 /kg	27200	26800	54000
Remark 备注	Boom angle 0°, with full water and fuel reservoirs, main hook, and aux. hook. 起重臂角度 0°、满水、满油、主钩、副钩		



Hook 吊钩

Rated load 额载 /t	Number of sheaves 滑轮数量	Rope rate 倍率	Hook weight/kg 吊钩重量
70	5	10	690
8	-	1	160



Operations 主要动作参数

Item 项目	Max. single rope lifting speed (empty load) 单绳速度 (空载)	Rope diameter/length 钢丝绳直径 / 长度	Max. single line pull 最大单绳拉力
Main winch 主卷扬	150m/min	Φ 20mm/250m	8.3t
Auxiliary winch 副卷扬	150m/min	Φ 20mm/145m	8.3t
Slewing speed 回转速度	1.8r/min		
Full luffing up/down time of boom 主臂起落幅时间	90s/95s		
Full extension/retraction time of boom 主臂伸缩时间	120s/125s		
Outrigger jack 垂直支腿	Extension 伸	35s	
	Retraction 缩	40s	
Outrigger beam 水平支腿	Extension 伸	30s	
	Retraction 缩	25s	

Working Conditions

工况组合



Telescopic boom on outriggers
主臂、支腿吊载

Fixed jib on outriggers
固定副臂、支腿吊载

Telescopic boom on tires
主臂、轮胎吊载

Operating Range - Telescopic Boom

起升高度曲线 - 主臂

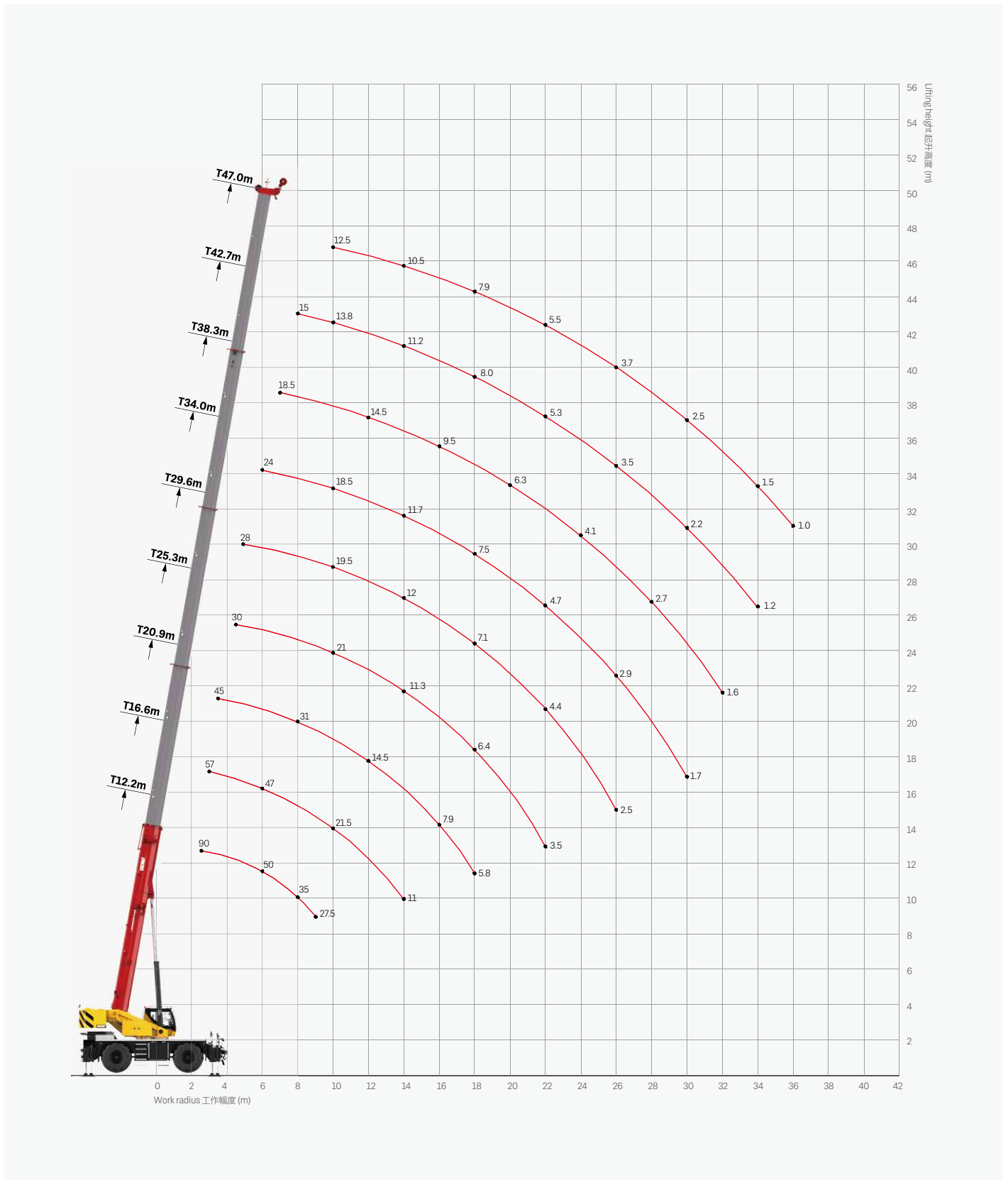







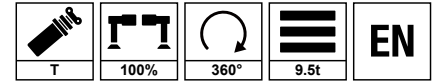









Load Chart-Telescopic Boom

性能表 - 主臂

Unit: kg



	12.2	16.6	16.6	20.9	20.9	20.9	25.3	25.3	25.3	29.6	
2.5	90000										2.5
3.0	85000	31000	57000								3.0
3.5	75000	31000	55000	29000	30500	45000					3.5
4.0	68000	31000	54000	29000	30500	45000					4.0
4.5	63000	31000	53000	29000	30500	45000	26000	28500	30000		4.5
5.0	58000	31000	52000	29000	30500	43000	26000	28500	30000	20000	5.0
5.5	54000	30500	50000	28000	30500	41000	26000	28500	30000	20000	5.5
6.0	50000	30000	47000	27000	29500	39000	26000	28000	29500	20000	6.0
6.5	46000	29500	43000	26000	29000	37000	25000	27000	29000	20000	6.5
7.0	42000	29000	39500	25000	28000	35000	24000	25500	28000	19500	7.0
8.0	35000	28000	33000	24000	25000	31000	22000	23500	25000	18500	8.0
9.0	27500	26500	27000	22500	23000	26000	21000	21500	23500	17500	9.0
10.0		23500	21500	21000	21000	22000	19000	19500	21000	16500	10.0
11.0		19600	17700	19000	18000	17300	18000	17500	18000	15500	11.0
12.0		16700	14900	17300	16000	14500	15800	15500	15500	14500	12.0
14.0		12000	11000	13200	11800	10500	13000	12500	11300	12200	14.0
16.0				10200	9000	7900	10600	9700	8500	10800	16.0
18.0				8100	6800	5800	8500	7500	6400	8900	18.0
20.0							6800	6000	4900	7300	20.0
22.0							5600	4800	3500	6000	22.0
24.0										5000	24.0
26.0										4200	26.0
28.0											28.0
30.0											30.0
32.0											32.0
34.0											34.0
36.0											36.0
38.0											38.0
	12	6	8	4	6	6	4	4	4	4	
	0%	0%	50%	0%	50%	100%	0%	50%	100%	0%	2# 
	0%	17%	0%	33%	17%	0%	50%	33%	17%	67%	3# 
	0%	17%	0%	33%	17%	0%	50%	33%	17%	67%	4# 
	0%	17%	0%	33%	17%	0%	50%	33%	17%	67%	5# 
	0	0	0	0	0	0	0	0	0	0	
	18000	10000	9000	6000	4500	4000	4500	3500	2000	2500	

Load Chart-Telescopic Boom

性能表 - 主臂

Unit: kg















	29.6	29.6	34.0	34.0	34.0	38.3	38.3	38.3	42.7	42.7	47.0		
2.5												2.5	
3.0												3.0	
3.5												3.5	
4.0												4.0	
4.5												4.5	
5.0	25000	28000										5.0	
5.5	25000	28000										5.5	
6.0	25000	28000	18000	19000	24000							6.0	
6.5	25000	27000	18000	19000	24000							6.5	
7.0	24500	25500	18000	19000	23500	15000	16000	18500				7.0	
8.0	22500	23000	17000	18500	21500	15000	16000	18500	14000	15000		8.0	
9.0	20500	21000	16000	18000	20000	14000	15500	17500	14000	14500		9.0	
10.0	19500	19500	14500	17500	18500	13000	15000	17000	13500	13800	12500	10.0	
11.0	18000	17500	13500	16500	17000	12000	14000	15500	12500	12800	12000	11.0	
12.0	16000	15300	12500	15000	15200	11000	12500	14500	11500	12000	11500	12.0	
14.0	12500	12000	11000	11500	11700	9500	11300	11500	10300	11200	10500	14.0	
16.0	9900	9200	9500	9700	9500	8500	9600	9500	9300	9300	9200	16.0	
18.0	7800	7100	8500	8200	7500	7700	8500	7800	8200	8000	7900	18.0	
20.0	6300	5600	7400	6600	5900	7000	6900	6300	7100	6500	6700	20.0	
22.0	5100	4400	6100	5400	4700	6300	5700	5100	5900	5300	5500	22.0	
24.0	4200	3400	5100	4400	3700	5300	4700	4100	4900	4300	4500	24.0	
26.0	3400	2500	4300	3600	2900	4500	3900	3300	4100	3500	3700	26.0	
28.0			3600	2900	2300	3800	3200	2700	3400	2800	3100	28.0	
30.0			3000	2300	1700	3200	2600	2100	2800	2200	2500	30.0	
32.0						2700	2100	1600	2300	1700	2000	32.0	
34.0						2300	1700		1900	1200	1500	34.0	
36.0									1500		1000	36.0	
38.0									1200			38.0	
	4	4	4	4	4	4	4	4	4	4	3		
	2#	50%	100%	0%	50%	100%	0%	50%	100%	50%	100%	100%	2#
	3#	50%	33%	83%	67%	50%	100%	83%	67%	100%	83%	100%	3#
	4#	50%	33%	83%	67%	50%	100%	83%	67%	100%	83%	100%	4#
	5#	50%	33%	83%	67%	50%	100%	83%	67%	100%	83%	100%	5#
		0	0	0	0	0	0	18	26	18	31	35	
		2000	1500	1500	1000	800	1000	800	800	800	800	800	

Load Chart-Telescopic Boom

性能表 - 主臂

Unit: kg



	12.2	16.6	16.6	20.9	20.9	20.9	25.3	25.3	25.3	29.6	
3.0	75000	29000	53000								3.0
3.5	65000	29000	51000	27000	28500	42000					3.5
4.0	60000	29000	49000	27000	28500	42000					4.0
4.5	54600	29000	48000	27000	28500	42000	24000	26500	28000		4.5
5.0	45200	29000	44000	27000	28500	40000	24000	26500	28000	18000	5.0
5.5	36500	29000	36000	26000	28000	35500	24000	26500	28000	18000	5.5
6.0	30300	28000	30000	25000	27000	29500	24000	26500	28000	18000	6.0
6.5	25700	27000	25000	24000	26000	25000	22500	25000	25700	18000	6.5
7.0	22200	23300	21500	23000	22400	21500	21500	23200	22200	18000	7.0
8.0	17100	18100	16500	18700	17200	16500	19000	18000	17100	17000	8.0
9.0	13600	14500	13000	15100	13700	13000	15500	14500	13500	15800	9.0
10.0		12000	10500	12500	11200	10500	12900	12000	11000	13200	10.0
11.0		10000	8600	10500	9300	8500	11000	10000	9100	11200	11.0
12.0		8500	7100	9000	7800	7000	9300	8500	7600	9600	12.0
14.0		6000	4900	6700	5600	4600	7000	6200	5400	7300	14.0
16.0				5100	4100	3200	5400	4600	3800	5600	16.0
18.0				3900	2900	1900	4200	3400	2600	4400	18.0
20.0							3300	2500	1800	3500	20.0
22.0							2600	1800		2800	22.0
24.0										2200	24.0
26.0										1700	26.0
28.0											28.0
30.0											30.0
	10	4	8	4	4	6	4	4	4	4	
	0%	0%	50%	0%	50%	100%	0%	50%	100%	0%	2#
	0%	17%	0%	33%	17%	0%	50%	33%	17%	67%	3#
	0%	17%	0%	33%	17%	0%	50%	33%	17%	67%	4#
	0%	17%	0%	33%	17%	0%	50%	33%	17%	67%	5#
	0	0	0	0	0	0	0	0	28	17	
	10000	5000	3500	2500	1500	1000	1500	1000	800	800	

Load Chart-Telescopic Boom

性能表 - 主臂

Unit: kg





	29.6	29.6	34.0	34.0	34.0	38.3	38.3	38.3	42.7	42.7	47.0	
3.0												3.0
3.5												3.5
4.0												4.0
4.5												4.5
5.0	23500	26000										5.0
5.5	23500	26000										5.5
6.0	23500	26000	16500	17000	23000							6.0
6.5	23500	25000	16500	17000	22500							6.5
7.0	22000	22000	16500	17000	22000	14000	15000	16000				7.0
8.0	18500	17700	16000	17000	18200	14000	15000	16000	13000	14000		8.0
9.0	15000	14100	15000	15300	14600	13000	14000	15000	13000	13000		9.0
10.0	12400	11600	13400	12700	12000	12000	13000	12400	12000	12000	11000	10.0
11.0	10400	9600	11400	10700	10000	11000	11000	10400	11000	10600	10500	11.0
12.0	8800	8100	9800	9100	8400	10000	9300	8800	9500	9000	9200	12.0
14.0	6500	5900	7500	6800	6200	7700	7000	6500	7200	6600	6900	14.0
16.0	4900	4300	5800	5200	4600	6000	5400	4900	5600	5000	5300	16.0
18.0	3700	3100	4600	4000	3400	4700	4200	3700	4400	3800	4100	18.0
20.0	2800	2200	3600	3100	2500	3800	3300	2800	3500	2900	3200	20.0
22.0	2200	1500	2900	2400	1800	3100	2600	2100	2800	2200	2500	22.0
24.0	1600		2300	1800	1200	2500	2000	1500	2200	1600	1900	24.0
26.0			1800	1300		2000	1500		1700	1100	1300	26.0
28.0			1300			1600			1300			28.0
30.0						1200						30.0
	4	4	4	4	4	4	4	4	4	4	3	
	50%	100%	0%	50%	100%	0%	50%	100%	50%	100%	100%	2#
	50%	33%	83%	67%	50%	100%	83%	67%	100%	83%	100%	3#
	50%	33%	83%	67%	50%	100%	83%	67%	100%	83%	100%	4#
	50%	33%	83%	67%	50%	100%	83%	67%	100%	83%	100%	5#
	27	35	26	33	39	32	42	46	44	48	52	
	800	800	800	800	800	800	800	800	800	800	800	

Load Chart-Telescopic Boom

性能表 - 主臂

Unit: kg



	12.2	16.6	16.6	20.9	20.9	20.9	25.3	25.3	25.3	29.6	
3.0	51000		50500								3.0
3.5	37000	27000	36200		26000	30000					3.5
4.0	28700	26000	28000	25000	25000	27700					4.0
4.5	23000	24000	22400	24600	23300	22100	22000	22500	23000		4.5
5.0	19000	20000	18400	20500	19300	18100	21000	19800	19000	17000	5.0
5.5	16000	17000	15400	17400	16300	15100	18000	16800	16000	17000	5.5
6.0	13700	14600	13100	15000	13900	12800	15500	14500	13700	15800	6.0
6.5	11800	12700	11300	13100	12000	11000	13600	12600	11800	13900	6.5
7.0	10300	11100	9800	11500	10500	9500	12000	11100	10300	12300	7.0
8.0	8000	8800	7500	9200	8200	7200	9600	8700	8000	9900	8.0
9.0	6500	7000	5800	7400	6500	5500	7800	7000	6200	8100	9.0
10.0		5700	4500	6100	5100	4200	6400	5700	4900	6700	10.0
11.0		4700	3500	5100	4100	3200	5400	4600	3900	5700	11.0
12.0		3800	2700	4200	3300	2400	4500	3800	3100	4800	12.0
14.0				2900	2100	1200	3200	2500	1800	3500	14.0
16.0				2000	1200		2300	1600		2500	16.0
18.0				1200			1600			1800	18.0
20.0										1200	20.0
22.0											22.0
24.0											24.0
26.0											26.0
	8	4	8	4	4	4	4	4	4	4	
2#	0%	0%	50%	0%	50%	100%	0%	50%	100%	0%	2#
3#	0%	17%	0%	33%	17%	0%	50%	33%	17%	67%	3#
4#	0%	17%	0%	33%	17%	0%	50%	33%	17%	67%	4#
5#	0%	17%	0%	33%	17%	0%	50%	33%	17%	67%	5#
	0	0	0	15	30	40	37	44	50	42	
	4000	1500	800	800	800	800	800	800	800	800	
	71	74	77	76	79	80	77	80	80	79	

Load Chart-Telescopic Boom

性能表 - 主臂

Unit: kg

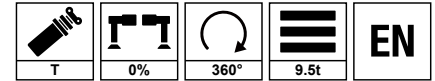

	29.6	29.6	34.0	34.0	34.0	38.3	38.3	38.3	42.7	42.7	47.0	
3.0												3.0
3.5												3.5
4.0												4.0
4.5												4.5
5.0	20000	19700										5.0
5.5	17500	16600										5.5
6.0	15000	14200	15000	15500	14700							6.0
6.5	13000	12300	14100	13500	12800							6.5
7.0	11500	10700	12500	11900	11200	12000	12100	11500				7.0
8.0	9100	8400	10100	9500	8800	10300	9700	9100	9500	9300		8.0
9.0	7400	6600	8300	7700	7100	8500	7900	7400	8100	7600		9.0
10.0	6000	5300	6900	6300	5700	7100	6500	6000	6700	6200	6400	10.0
11.0	5000	4300	5900	5300	4700	6000	5500	5000	5700	5200	5400	11.0
12.0	4100	3500	5000	4400	3800	5100	4600	4100	4800	4300	4500	12.0
14.0	2800	2200	3700	3100	2500	3800	3300	2800	3500	3000	3200	14.0
16.0	1900	1300	2700	2200	1600	2800	2300	1900	2500	2000	2200	16.0
18.0	1200		2000	1500		2100	1600		1800	1300	1500	18.0
20.0			1400			1500						20.0
22.0												22.0
24.0												24.0
26.0												26.0
	4	4	4	4	4	4	4	4	4	4	3	
	50%	100%	0%	50%	100%	0%	50%	100%	50%	100%	100%	2#
	50%	33%	83%	67%	50%	100%	83%	67%	100%	83%	100%	3#
	50%	33%	83%	67%	50%	100%	83%	67%	100%	83%	100%	4#
	50%	33%	83%	67%	50%	100%	83%	67%	100%	83%	100%	5#
	47	52	49	53	57	54	57	60	60	61	64	
	800	800	800	800	800	800	800	800	800	800	800	
	80	80	80	80	80	80	80	80	80	80	80	

Remark

1. Load capacity in the chart is the maximum weight which this crane could hoist include the weight of hook blocks and riggings.
2. Radius shown in the chart is the actual radius when loading.
3. The load capacity in the chart is the maximum weight when this crane is supported with the firm ground and stays in level.
4. Choose rated load capacity of the longer boom and radius when the actual boom length and radius are between two values in the charts.
5. The machine can be used only when the wind power is less than grade 6.

1. 性能表中额定起重量包括起重钩和吊具的重量。
2. 性能表中工作幅度是指吊载后的实际幅度。
3. 性能表中给定数值是在平整坚固的地面上，整机调平状态下起重机的最大起重量。
4. 如实际臂长和幅度介于两个数值之间时，取较长的臂长及较大的幅度所决定的额定起重量进行起重作业。
5. 起重作业风力等级需低于 6 级。

Operating Range - Fixed Jib

起升高度曲线 - 副臂

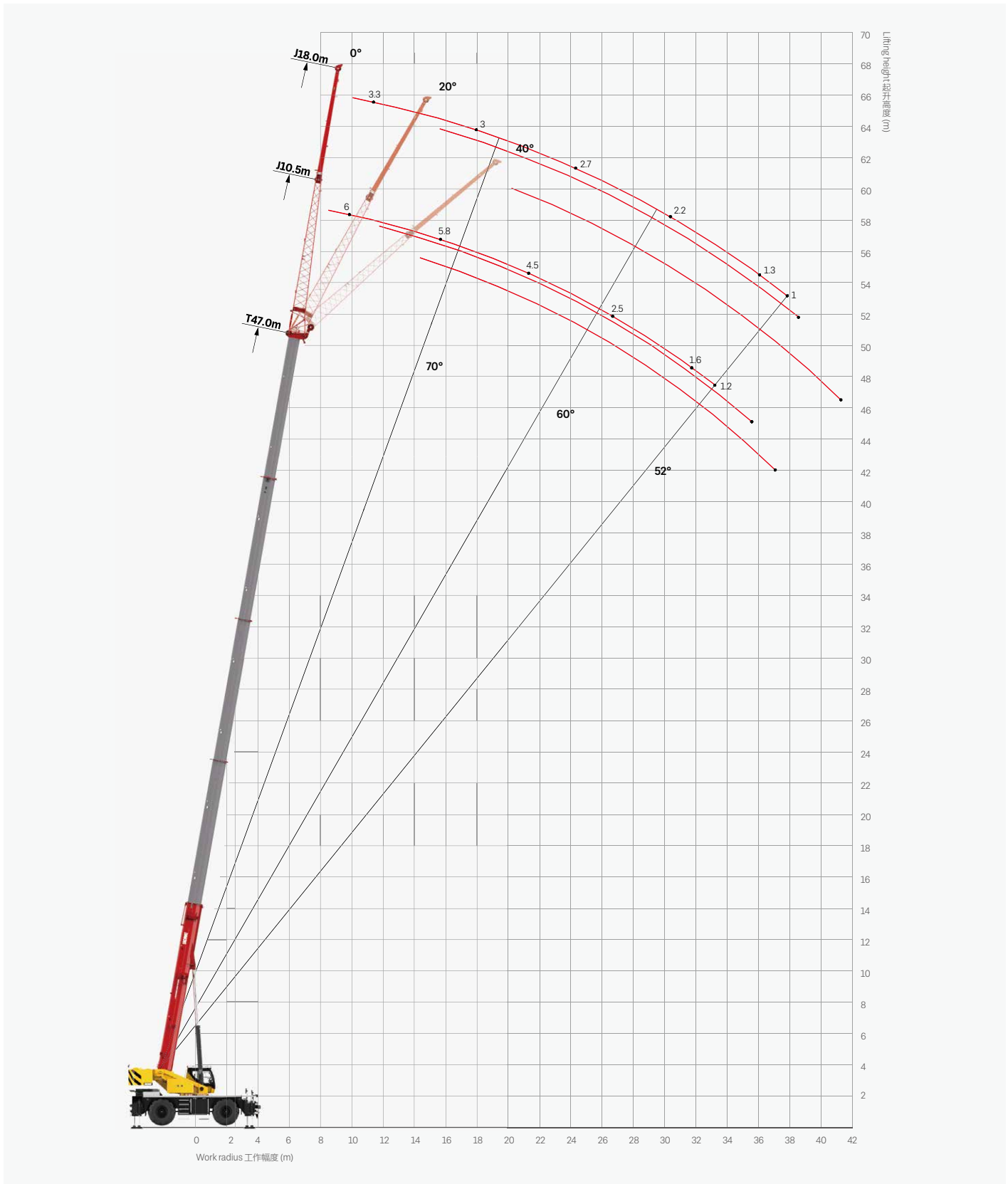

Load Chart - Fixed Jib

性能表 - 副臂

Unit: kg

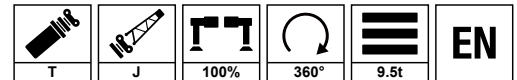

m 	47.0 + 10.5						47.0 + 18.0						m
	0°		20°		40°		0°		20°		40°		
	m	kg	m	kg	m	kg	m	kg	m	kg	m	kg	
80.0	7.7	6000	11.2	5000	14.0	4400	9.0	3400	14.9	2600	19.7	2100	80.0
78.0	9.7	6000	13.1	4800	15.8	4300	11.3	3300	17.1	2600	21.7	2100	78.0
76.0	11.7	6000	15.0	4600	17.6	4200	13.5	3200	19.2	2500	23.7	2100	76.0
74.0	13.6	6000	16.9	4300	19.4	4100	15.7	3100	21.3	2400	25.6	2000	74.0
72.0	15.5	5800	18.7	4100	21.2	3900	17.8	3000	23.4	2300	27.5	1900	72.0
70.0	17.4	5500	20.6	3800	22.9	3700	20.0	2900	25.4	2200	29.4	1800	70.0
68.0	19.3	5000	22.4	3500	24.6	3400	22.1	2800	27.4	2100	31.2	1700	68.0
66.0	21.1	4500	24.2	3100	26.3	2800	24.2	2700	29.4	2000	33.0	1600	66.0
64.0	23.0	3700	25.9	2700	27.9	2700	26.2	2600	31.3	1900	34.8	1500	64.0
62.0	24.7	3100	27.6	2500	29.6	2500	28.3	2400	33.2	1700	36.5	1400	62.0
60.0	26.5	2500	29.3	2300	31.1	2100	30.3	2200	35.0	1600	38.2	1300	60.0
58.0	28.2	2100	30.9	1800	32.6	1600	32.2	1900	36.8	1400	39.8	1200	58.0
56.0	29.9	1800	32.5	1300	34.1	1200	34.1	1600	38.6	1100	41.3	1100	56.0
54.0	31.5	1600	34.1	1200	35.6	1100	36.0	1300					54.0
52.0	33.2	1200	35.6	1100	37.0	1000	37.8	1000					52.0
	1		1		1		1		1		1		
	2#	100%	100%	100%	100%	100%	100%	100%	100%	100%	100%	100%	2#
	3#	100%	100%	100%	100%	100%	100%	100%	100%	100%	100%	100%	3#
	4#	100%	100%	100%	100%	100%	100%	100%	100%	100%	100%	100%	4#
	5#	100%	100%	100%	100%	100%	100%	100%	100%	100%	100%	100%	5#
	50		50		50		50		54		54		
	700		600		500		500		600		600		

Load Chart - Telescopic Boom, On Tires Stationary, Load Over Front

性能表 - 轮胎静止吊载 (正前方)

Unit: kg



	12.2	16.6	20.9	25.3	29.6	
4.0	22400	22000	21000			4.0
4.5	20300	20900	20000	19500		4.5
5.0	18300	19000	19000	18000	17000	5.0
5.5	16900	17000	18000	16000	16000	5.5
6.0	14800	15000	16500	15000	15000	6.0
6.5	12800	13500	14500	14000	14000	6.5
7.0	11200	12300	13000	13000	13000	7.0
8.0	8600	9500	10300	10500	11000	8.0
9.0	6700	7800	8500	8900	9200	9.0
10.0		6200	7000	7300	7700	10.0
11.0		5200	5800	6200	6500	11.0
12.0		4200	4900	5200	5500	12.0
14.0			3400	3800	4000	14.0
16.0			2300	2700	3000	16.0
18.0			1500	1800	2100	18.0
20.0					1500	20.0
	4	4	4	4	4	
	2#	0%	0%	0%	0%	2#
	3#	0%	17%	33%	50%	3#
	4#	0%	17%	33%	50%	4#
	5#	0%	17%	33%	50%	5#
	0	0	0	36	41	
	4000	2500	800	800	800	
	80	80	80	80	80	

Load Chart - Telescopic Boom, Pick & Carry, Load Over Front

性能表 - 主臂帶載行駛 (正前方)

Unit: kg



	12.2	16.6	20.9	25.3	29.6	
4.0	14300	14000	14000			4.0
4.5	12900	13500	13600	13800		4.5
5.0	11600	12200	12500	12800	13000	5.0
5.5	10500	11100	11500	11700	11900	5.5
6.0	9600	10200	10600	10800	11000	6.0
6.5	8700	9300	9700	10000	10100	6.5
7.0	7900	8600	8800	9200	9400	7.0
8.0	6600	7300	7600	7800	8100	8.0
9.0	5500	6200	6600	6800	7100	9.0
10.0		5400	5800	6000	6200	10.0
11.0		4500	5000	5200	5500	11.0
12.0		3700	4200	4500	4600	12.0
14.0			3000	3300	3500	14.0
16.0			2000	2300	2500	16.0
18.0					1600	18.0
	4	4	4	4	4	
	2#	0%	0%	0%	0%	2#
	3#	0%	17%	33%	50%	3#
	4#	0%	17%	33%	50%	4#
	5#	0%	17%	33%	50%	5#
	0	0	30	44	47	
	3000	1500	800	800	800	
	80	80	80	80	80	

Load Chart - Telescopic Boom, On Tires Stationary, 360° Slewing

性能表 - 轮胎静止吊载(360°)



Unit: kg

	12.2	16.6	20.9	25.3	29.6	
4.0	15500					4.0
4.5	13000					4.5
5.0	10500	10700				5.0
5.5	9000	9100				5.5
6.0	7600	7900	8500			6.0
6.5	6500	6900	7500	8000		6.5
7.0	5500	6000	6500	7000	7200	7.0
8.0	4100	4600	5000	5500	5800	8.0
9.0	3000	3600	4000	4500	4800	9.0
10.0		2800	3100	3500	3800	10.0
11.0		2100	2400	2800	3000	11.0
12.0		1500	1800	2200	2300	12.0
	4	4	4	4	4	
	2#	0%	0%	0%	0%	2#
	3#	0%	17%	33%	50%	3#
	4#	0%	17%	33%	50%	4#
	5#	0%	17%	33%	50%	5#
	0	32	48	56	61	
	1000	800	800	800	800	
	65	69	71	73	75	

Remark

1. Capacities are applicable at 525kPa cold tire inflation pressure.
2. Capacities are applicable only with machine on firm level surface.
3. On tire lifting with the jib mounted is not permitted.
4. Axle lockouts must be applied when lifting on tires.
5. Parking brake must be applied when lifting on tires stationary.
6. Driving speed shall be ~4km/h at pick & carry mode.

1. 冷态轮胎气压需保持 525kPa。
2. 起重机需在平整坚固的地面上作业。
3. 轮胎吊载工况不允许使用副臂吊载。
4. 轮胎吊载工况中，车桥悬挂需锁定。
5. 轮胎静止吊载工况中，需使用驻车制动。
6. 带载行驶工况中，直线行驶速度需小于等于 4km/h。